

NIARAYS



ACCESSORIES
ACCESSOIRES

LAUFEN



NIARA

Architectural forms with NIARA, a comprehensive collection of accessories with a minimalistic design, in a colour palette mirroring LAUFEN faucets for a harmonious aesthetic throughout the bathroom.

At the heart of NIARA lies a philosophy that eschews the temporary allure of trends for a focus on sustainability, safety, and strength, offering an enduring design without compromising on style.

NIARA, with its rounded form, offers a minimalistic aesthetic and is available in a sophisticated colour palette of six finishes; Chrome, Inox, Rose Gold Polished, Titanium Black Matt, Pale Gold Matt and Rose Gold Brushed.

Architektonische Formen mit NIARA, einer umfassenden Kollektion von Accessoires mit minimalistischem Design, in einer Farbpalette, die die LAUFEN Armaturen widerspiegelt und eine harmonische Ästhetik im ganzen Bad erweckt.

NIARA verfolgt die Philosophie, den Verlockungen von vorübergehenden Trends zu trotzen und stattdessen Nachhaltigkeit, Langlebigkeit und Robustheit in den Mittelpunkt zu stellen, um ein unvergängliches und kompromisslos stilvolles Design zu bieten.

Mit seinen abgerundeten Formen bietet NIARA eine minimalistische Ästhetik und ist in einer anspruchsvollen Farbpalette mit sechs Oberflächen erhältlich: Chrom, Edelstahl gebürstet, Roségold poliert, Titanschwarz matt, Blassgold matt und Roségold gebürstet.







EASY, VERSATILE INSTALLATION

NIARA introduces a revolutionary dual installation system, offering the freedom to install bathroom accessories with or without the need for a drill. Enter the ingenious SmartFast, an innovative adhesive allowing for the seamless installation of bathroom accessories. Complementing this, the Triple Screw Fixing Design ensures that, should drilling be required, each accessory is anchored with additional security. NIARA is additionally designed with an anti-rotation metal core, maintaining the precise alignment and orientation of each piece over time.

ARCHITECTURAL DESIGN DETAILS

The meticulous attention to detail in the design stands out, as evidenced by the clever integration of a mobile phone holder in the toilet roll holder and intense testing to ensure long lasting durability. These features not only infuse the space with elegance but also bring a layer of practicality to your daily bathroom routine, seamlessly blending form with function for an elevated experience

EINFACHE UND FLEXIBLE INSTALLATION

NIARA führt ein revolutionäres duales Installationssystem ein, das die Freiheit bietet, Badaccessoires mit oder ohne Bohrer zu installieren. Der geniale SmartFast-Kleber ist ein innovatives Klebesystem, welches eine nahtlose Installation von Badaccessoires ermöglicht. Ergänzend dazu sorgt das Dreifach-Schrauben-Befestigungssystem dafür, dass jedes Zubehör fest verankert ist, falls Bohren gewünscht oder erforderlich sein sollte. Dieses ist zusätzlich mit einem Anti-Rotations-Metallkern ausgestattet, der die präzise Ausrichtung der Elemente langfristig garantiert.

DESIGN MIT ARCHITEKTONISCHEN DETAILS

Die Kollektion ist bis ins letzte Detail durchdacht, wie die clevere Integration eines Handyhalters in den Toilettenpapierhalter und die intensiven Tests zur Gewährleistung einer langen Haltbarkeit beweisen. Diese Merkmale verleihen dem Raum nicht nur Eleganz, sondern bringen durch die nahtlose Verbindung von Form und Funktion auch eine praktische Ebene in die tägliche Routine und sorgen so für ein gehobenes Erlebnis im Badezimmer.



ACCESSORIES | ACCESSOIRES



.004
Chrome
Chrom



.161
Inox brushed look
PVD Inox Look



.162
Rosegold polished
PVD Rosegold



.163
Titanium black matt
PVD Titanschwarz matt



.165
Pale gold matt
PVD Blassgold matt



.168
Rosegold brushed
PVD Roségold gebürstet

NIARA

 = Wall mounting for drilling or gluing / Wandbefestigung zum Bohren oder Kleben



H381061xxx0001
Towel rail
Handtuchhalter

004 161 162 163 165 168
468 × 86 × 58 mm

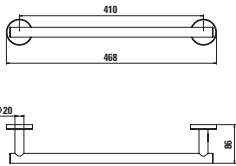

H381062xxx0001
Towel rail
Handtuchhalter

004 161 162 163 165 168
602 × 86 × 58 mm

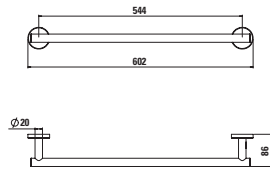

H381062xxx0011
Towel rail
Handtuchhalter

004 161 162 163 165 168
830 × 88 × 66 mm

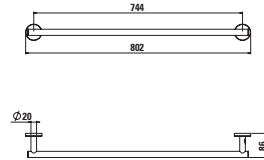

H381062xxx0021
Double towel rail
Doppelhandtuchhalter

004 161 162 163 165 168
602 × 134 × 58 mm

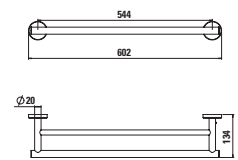

H382061xxx0001
Wall-mounted Tumbler / toothbrush holder
Zahnputzbecherhalter

004 161 162 163 165 168
62 × 83 × 134 mm

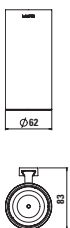

H382061xxx0011
Wall-mounted Twin Tumbler / Double toothbrush holder
Doppel-Zahnputzbecherhalter

004 161 162 163 165 168
140 × 85 × 134 mm

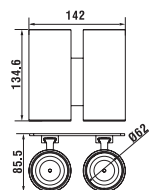

H383062xxx0001
Wall soap dispenser, 240 ml
Seifenspender, 240 ml

004 161 162 163 165 168
62 × 107 × 187 mm

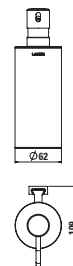

H384061xxx0001
Toilet brush holder incl. toilet brush
Bürstenhalter inkl. WC-Bürste

004 161 162 163 165 168
90 × 112 × 387 mm

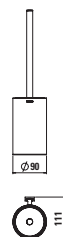



H381062xxx0031
Towel rail with shelf
Handtuchhalter-Regal

004 161 162 163 165 168
553 × 302 × 134 mm

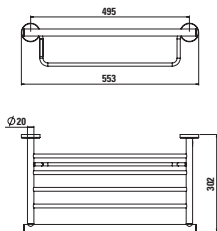

H384062xxx0041
Toilet roll holder with shelf cover
Papierrollenhalter mit Abdeckung

004 161 162 163 165 168
132 × 65 × 105 mm

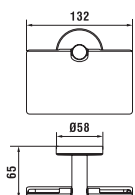

H381061xxx0011
Double towel rail, swivelling
Schwenkbarer Doppelhandtuchhalter

004 161 162 163 165 168
78 × 402 × 45 mm

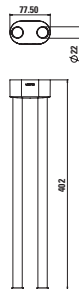

H384062xxx0001
Toilet roll holder without cover
Papierrollenhalter ohne Abdeckung

004 161 162 163 165 168
172 × 82 × 58 mm

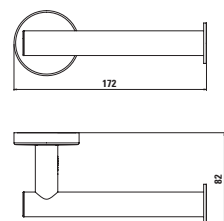

H381064xxx0001
Towel ring
Handtuchhalter

004 161 162 163 165 168
226 × 72 × 164 mm

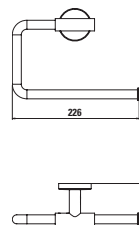

H384062xxx0011
Double toilet roll holder without cover
Doppel-Papierrollenhalter ohne Abdeckung

004 161 162 163 165 168
245 × 82 × 58 mm

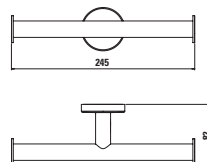

H381063xxx0001
Towel hook
Handtuchhaken

004 161 162 163 165 168
58 × 61 × 58 mm

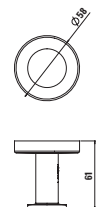

H384062xxx0021
Vertical toilet roll holder
Papierrollenhalter vertikal

004 161 162 163 165 168
58 × 95 × 176 mm

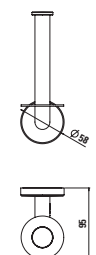

NIARA

  = Wall mounting for drilling or gluing / *Wandbefestigung zum Bohren oder Kleben*



H384062xxx0031

Toilet roll holder with shelf
Papierrollenhalter mit Ablage



159 × 112 × 88 mm

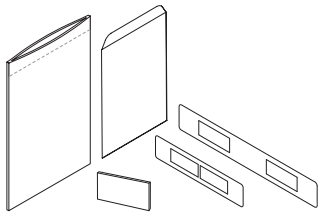
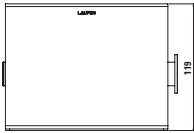
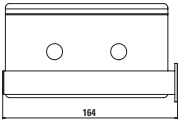

H3800610000021

NIARA adhesive kit
for shower containers
*NIARA Klebeset
für Duschkörbe*



H385061xxx0011

Wall basket for shower
Dusch-Wandkorb



300 × 106 × 81 mm

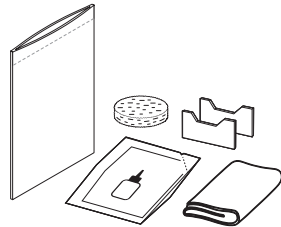
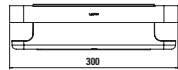

H3800610000031

Adhesive kit universal
(for soap dispenser, toothbrush holder,
toilet roll holder with shelf and toilet
brush holder)

*Klebeset Universal
(für Seifenspender, Zahnbürstenhalter,
Papierrollenhalter mit Ablage und
Bürstenhalter)*



H385061xxx0021

Corner wall basket for shower
Dusch-Eckwandkorb



214 × 214 × 80 mm

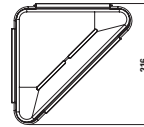

H385062xxx0001

Shelf 40 cm
Ablageplatte 40 cm



400 × 109 × 20 mm

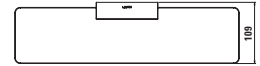
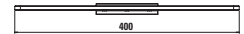



H386061xxx0001
Wall mirror with magnifying glass (x 3)
Vergrößerungs-Wandspiegel (x 3)

004 161 162 163 165 168
200 x 317 x 200 mm

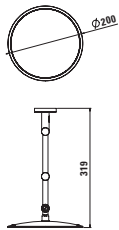

H389060xxx0001
Grab bar
Haltestange

004 161 162 163 165 168
300 x 68 x 60 mm

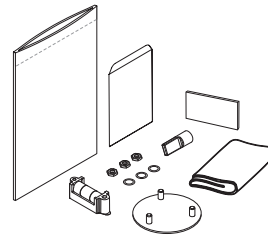
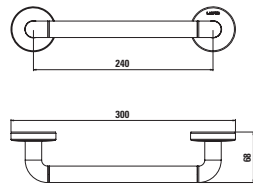

H3800610000001
NIARA simple adhesive kit
for accessories with 1 support
*NIARA Klebeset einfach
für Zubehör mit 1 Halterung*

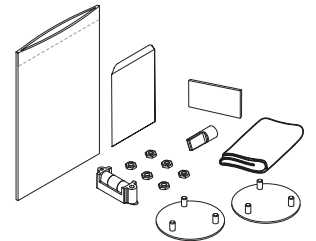

H3800610000011
NIARA double adhesive kit
for accessories with 2 supports
*NIARA-Doppelklebeset
für Zubehör mit 2 Halterungen*





NIARA S

For those seeking a more angular aesthetic, NIARA S. An extensive collection meticulously crafted to deliver peak functionality, embodying the core values of LAUFEN: safety, superiority, sustainability, and strength. NIARA S presents a defined, architectural angular form in three distinct finishes; Chrome, Inox and Titanium Black Matt.

Für diejenigen, die eine kantigere Ästhetik suchen, NIARA S. Eine umfangreiche Kollektion, die mit Sorgfalt auf höchste Funktionalität ausgelegt ist und die Kernwerte von LAUFEN verkörpert: Sicherheit, Souveranität, Nachhaltigkeit und Langlebigkeit.

NIARA S präsentiert eine definierte, architektonische, kantige Form in drei verschiedenen Oberflächen: Chrom, Edelstahl gebürstet und Titan Schwarz Matt.



ACCESSORIES | *ACCESSOIRES*

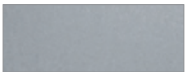

.004
Chrome
Chrom



.161
Inox brushed look
PVD Inox Look



.163
Titanium black matt
PVD Titanschwarz matt

NIARA S

 = Wall mounting for drilling or gluing / *Wandbefestigung zum Bohren oder Kleben*



H381071xxx0001
Towel rail
Handtuchhalter

004 161 163
468 × 86 × 58 mm

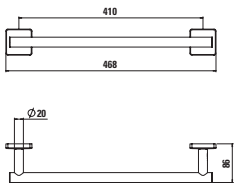

H381072xxx0001
Towel rail
Handtuchhalter

004 161 163
602 × 86 × 58 mm

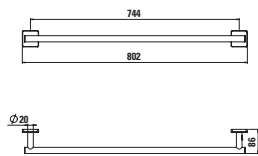

H381072xxx0011
Towel rail
Handtuchhalter

004 161 163
820 × 100 × 68 mm

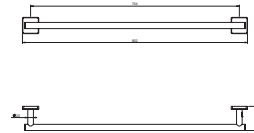

H381072xxx0021
Double towel rail
Doppelhandtuchhalter

004 161 163
602 × 134 × 58 mm

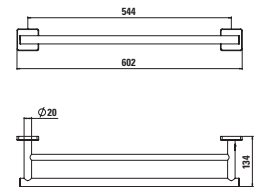

H384072xxx0001
Toilet roll holder without cover
Papierrollenhalter ohne Abdeckung

004 161 163
172 × 82 × 58 mm

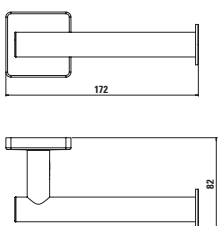

H384072xxx0011
Double toilet roll holder without cover
Doppel-Papierrollenhalter ohne Abdeckung

004 161 163
245 × 82 × 58 mm

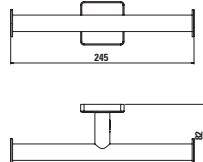

H384072xxx0021
Vertical toilet roll holder
Papierrollenhalter vertikal

004 161 163
58 × 95 × 176 mm



H386071xxx0001
Wall mirror with magnifying glass (× 3)
Vergößerungs-Wandspiegel (× 3)

004 161 163
200 × 317 × 200 mm

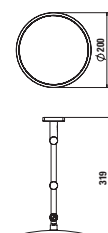



H381072xxx0031
Towel rail with shelf
Handtuchhalter-Regal

004 161 163
553 × 302 × 134 mm

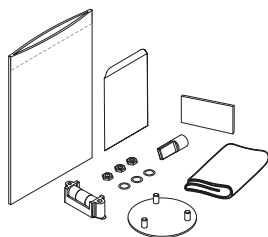
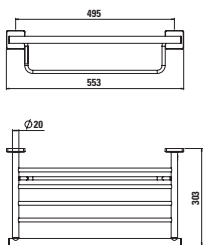

H380061000001
NIARA simple adhesive kit
for accessories with 1 support
*NIARA Klebeset einfach
für Zubehör mit 1 Halterung*



H381074xxx0001
Towel ring
Handtuchhalter

004 161 163
226 × 72 × 164 mm

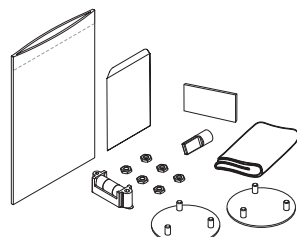
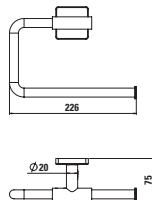

H3800610000011
NIARA double adhesive kit
for accessories with 2 supports
*NIARA-Doppelklebeset
für Zubehör mit 2 Halterungen*



H381073xxx0001
Towel hook
Handtuchhaken

004 161 163
58 × 61 × 58 mm

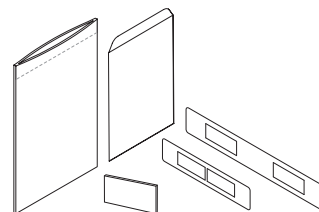
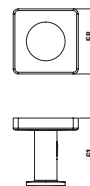

H3800610000021
NIARA adhesive kit
for shower containers
*NIARA Klebeset
für Duschkörbe*



H384072xxx0031
Toilet roll holder with shelf cover
Papierrollenhalter mit Abdeckung

004 161 163
132 × 67 × 105 mm

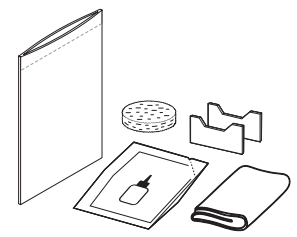
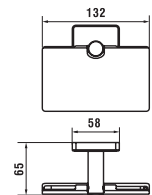

H3800610000031
Adhesive kit universal
(for soap dispenser, toothbrush holder,
toilet roll holder with shelf and toilet
brush holder)
*Klebeset Universal
(für Seifenspender, Zahnbürstenhalter,
Papierrollenhalter mit Ablage und
Bürstenhalter)*

SCREW FIXING MONTAGE BOHREN

Triple Screw Fixing System:

This strong and universal anchoring solution offers superior performance. It is the first smart anchoring system that adapts to the wall material, choosing to expand, fold, or knit together for optimal stability.

Dreifach-Schrauben-Befestigungssystem:

Starke und universelle Verankerungslösung mit überlegener Leistung. Die ist das erste intelligente Verankerungssystem, das sich je nach Wandmaterial ausdehnt, faltet oder zusammenfügt, um optimale Stabilität zu gewährleisten.

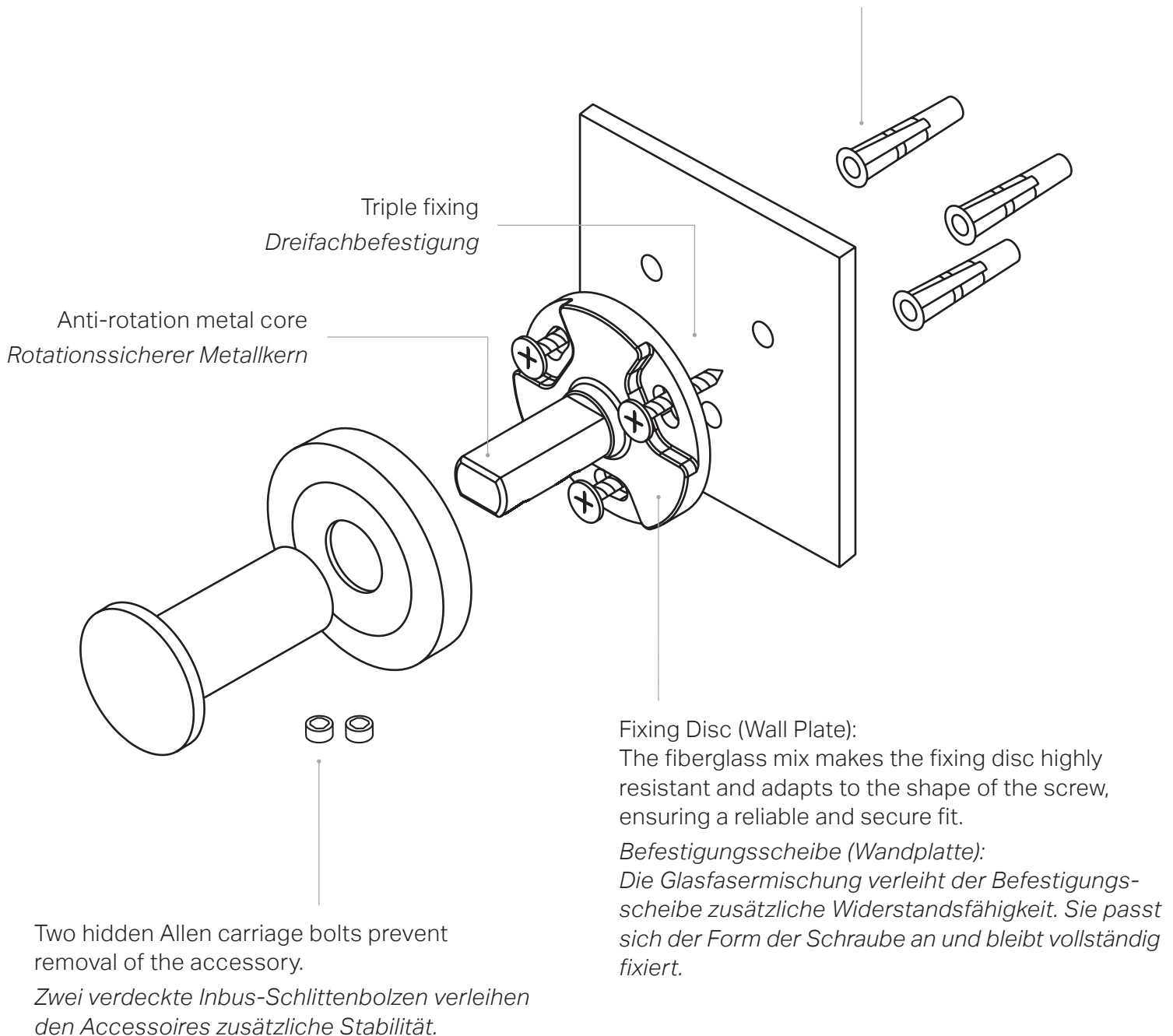

ADHESIVE FIXING MONTAGE KLEBEN





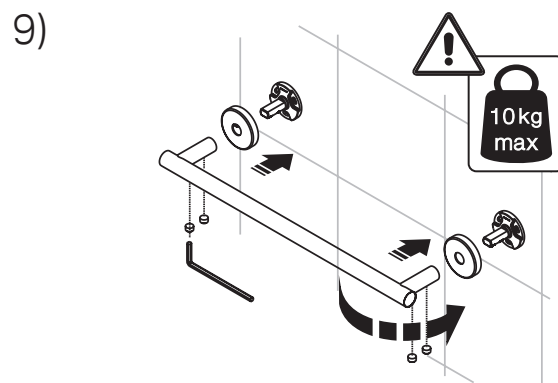
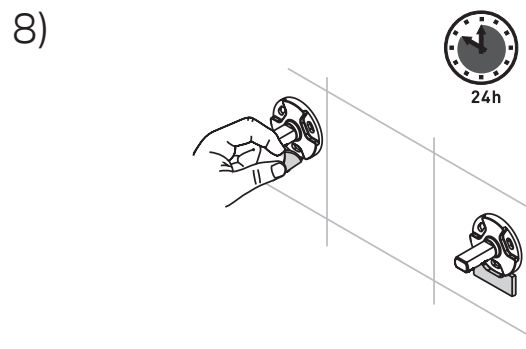
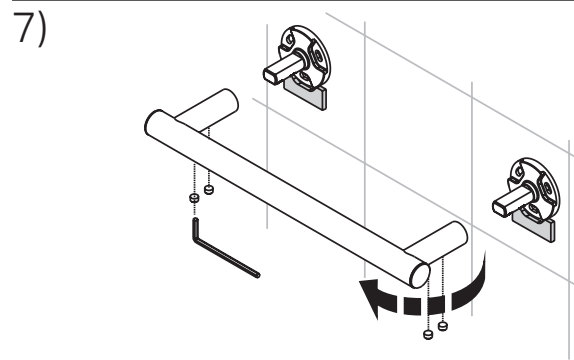
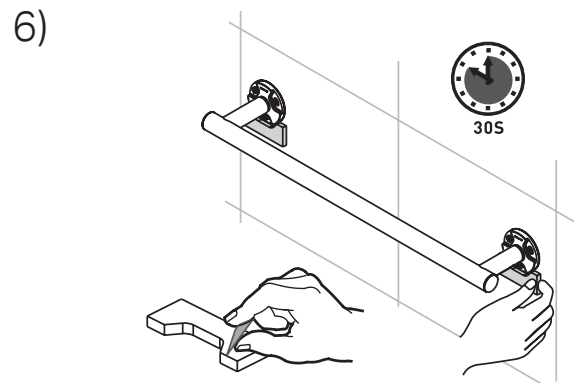
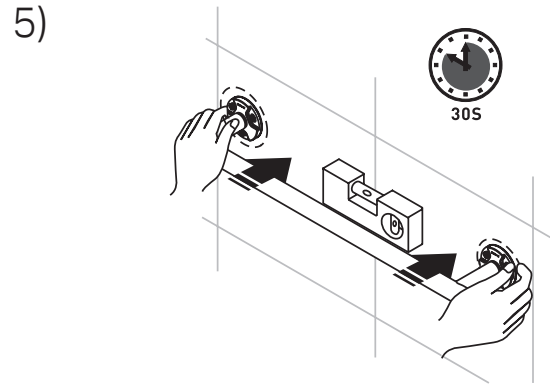
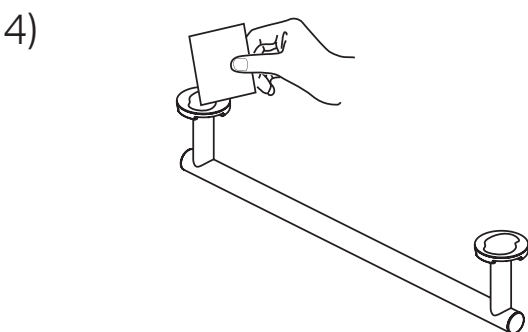
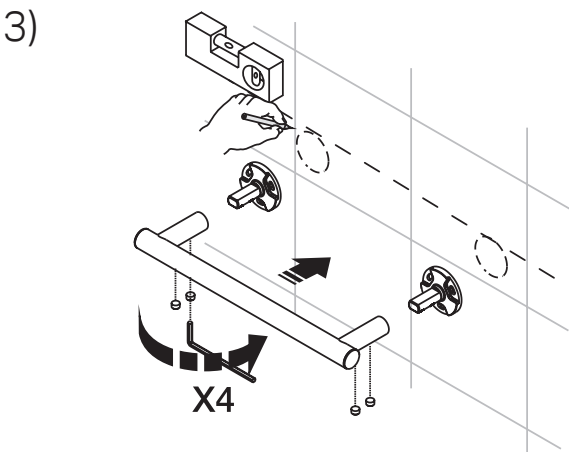
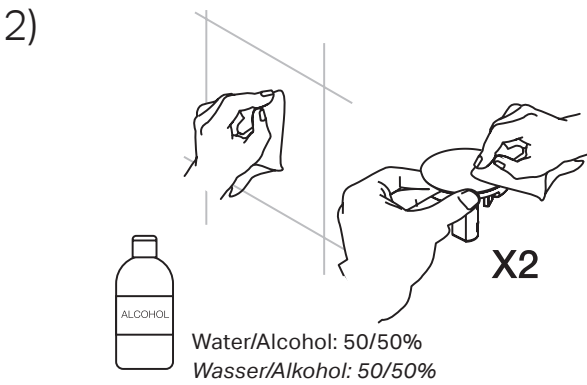
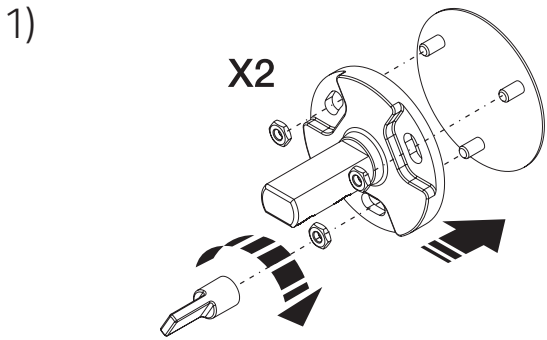























Assembly video
Montagevideo



INSTALLATION OPTIONS

MONTAGEOPTIONEN

Adhesive kit / Klebeset

Niara		Niara S		H 3 8006 1 000 000 1 NIARA simple adhesive kit for accessories with 1 support NIARA Klebeset einfach für Zubehör mit 1 Halterung	H 3 806 1 000 001 1 NIARA double adhesive kit for accessories with 2 supports NIARA-Doppelklebeset für Zubehör mit 2 Halterungen	H 3 8006 1 000 002 1 NIARA adhesive kit for shower containers NIARA Klebeset für Duschkörbe	H 3 8006 1 000 003 1 Adhesive kit universal (for soap dispenser, toothbrush holder, toilet roll holder with shelf and toilet brush holder) Klebeset Universal (für Seifen- spender, Zahnbürstenhalter, Papierrollenhalter mit Ablage und Bürstenhalter)	Screws / Schrauben
	H 3 8106 1 xxx 000 1 H 3 8106 2 xxx 000 1 H 3 8106 2 xxx 001 1		H 3 8107 1 xxx 000 1 H 3 8107 2 xxx 000 1 H 3 8107 2 xxx 001 1		●			●
	H 3 8106 1 xxx 001 1							●
	H 3 8106 2 xxx 002 1		H 3 8107 2 xxx 002 1		●			●
	H 3 8106 2 xxx 003 1		H 3 8107 2 xxx 003 1					●
	H 3 8106 3 xxx 000 1		H 3 8107 3 xxx 000 1	●				●
	H 3 8106 4 xxx 000 1		H 3 8107 4 xxx 000 1	●				●
	H 3 8206 1 xxx 000 1						●	●
	H 3 8306 2 xxx 000 1						●	●
	H 3 8406 1 xxx 000 1						●	●
	H 3 8406 2 xxx 000 1		H 3 8407 2 xxx 000 1	●				●
	H 3 8406 2 xxx 001 1		H 3 8407 2 xxx 001 1	●				●
	H 3 8406 2 xxx 002 1		H 3 8407 2 xxx 002 1	●				●
	H 3 8406 2 xxx 003 1						●	●
	H 3 8506 1 xxx 001 1					●		●
	H 3 8506 1 xxx 002 1					●		●
	H 3 8506 2 xxx 000 1							●
	H 3 8906 0 xxx 000 1							●
	H 3 8606 1 xxx 000 1		H 3 8607 1 xxx 000 1					●



Colours shown may not be absolutely identical to the actual colours. Bathroom environments shown here are simply decorative settings and do not take all technical requirements into consideration. Decorations shown are not included in our range of products.

We reserve the right to change specifications without prior notice. Design is copyright protected.

It is possible that not all products, sizes or colours are available in every country. The price list of your LAUFEN subsidiary is the most accurate reference point for product availability. Delivery periods may differ.

Die Farbabbildungen entsprechen nur in etwa den tatsächlichen Farbtönen. Die hier gezeigten Badmilleus sind rein dekorativ und berücksichtigen nicht alle technischen Anforderungen. Unser Angebot beinhaltet nicht die verwendete Dekoration.

Technische Änderungen sind vorbehalten. Design geschützt.

Unter Umständen sind nicht alle Produkte, Grössen oder Farben in jedem Land verfügbar. Bitte nutzen Sie die Preisliste der jeweiligen LAUFEN Niederlassung als Referenz für das verfügbare Produktsortiment. Auch die jeweiligen Lieferzeiten können von Land zu Land abweichen.



www.laufen.com



LAUFEN Bathrooms AG
Wahlenstrasse 46, 4242 Laufen
Switzerland
Tel. +41 61 765 71 11
feedback@laufen.ch