

## SOLUTIONS 2.0

### Shower tray with outlet on the short side

#### DIMENSIONS

Length	1600 mm
Width	800 mm
Height	32 mm

#### COLOURS AND FINISHES

<input type="checkbox"/>	000 White
--------------------------	-----------

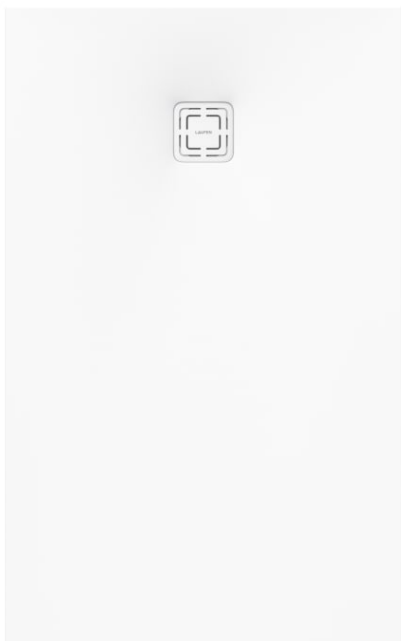

Commodity Code/Import Code Number for Foreign Trad : 39221000  
Depth : Superslim (less than 45mm)

Material : Marbond  
Net weight (kg) : 62.55

Shape : Rectangular

#### TECHNICAL DRAWINGS

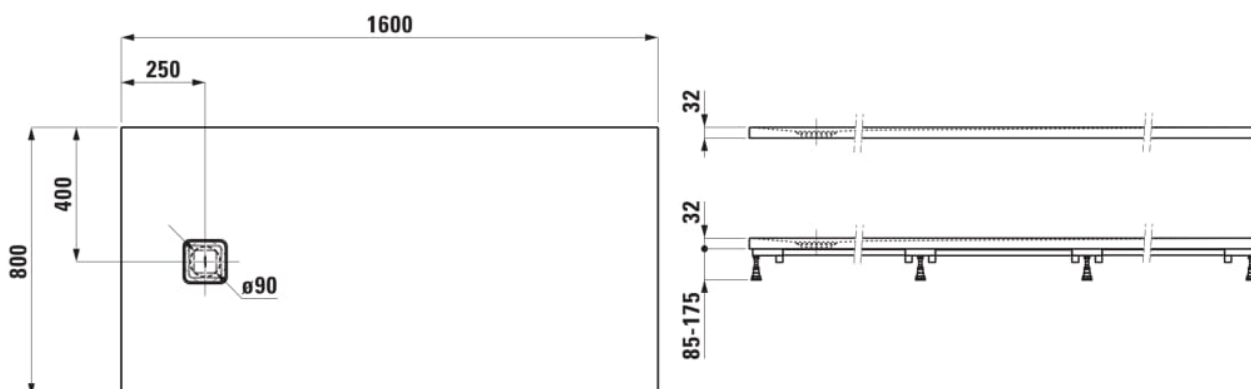

COMPATIBLE WITH



Installation frame for  
Marbond shower tray

**H2957380000001**

## SOLUTIONS 2.0

#material\_text

MARBOND

## Marbond

Marbond is a composite material made of two layers which are extremely well connected with each other: The basis is formed by a high-quality mineral casting material, the surface is coated with a two millimetre thick acrylic layer. Marbond is hygienic, easy to clean, temperature resistant according to EN 263 and anti-slip (class C).