

MEDA

Bathtub, back-to-wall version, made of Marbond composite material



DIMENSIONS

| | |
|--------|---------|
| Length | 1800 mm |
| Width | 800 mm |
| Height | 590 mm |

COLOURS AND FINISHES

000 White

#option

000 - standard option

#mountingAccessoriesExcluded_text

Noise control band, order no. 29555.1

Commodity Code/Import Code Number for Foreign Trad : 39221000

Drain : Included

Installation structure : With feet

Installation type : Back to wall

Internal height (mm) : 1235

Material : Marbond

Net weight (kg) : 134

Shape : Oval

Waste diameter (mm) : 52

Water capacity to overflow (l) : 260

TECHNICAL DRAWINGS

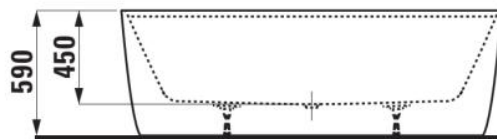
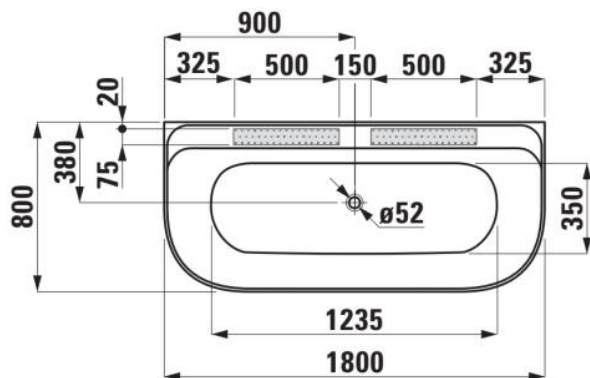

COMPATIBLE WITH



Neck cushion, black, self-adhesive, for curved bathtub contours

H294103...0001

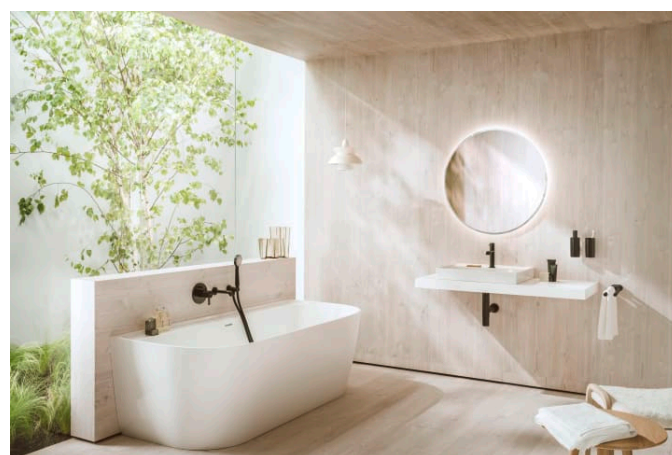

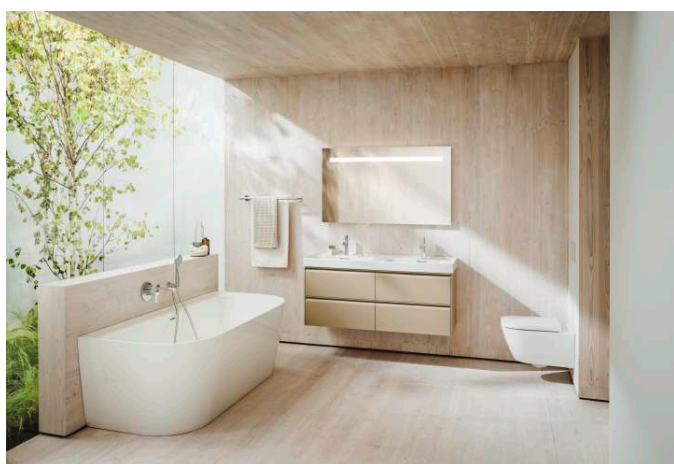
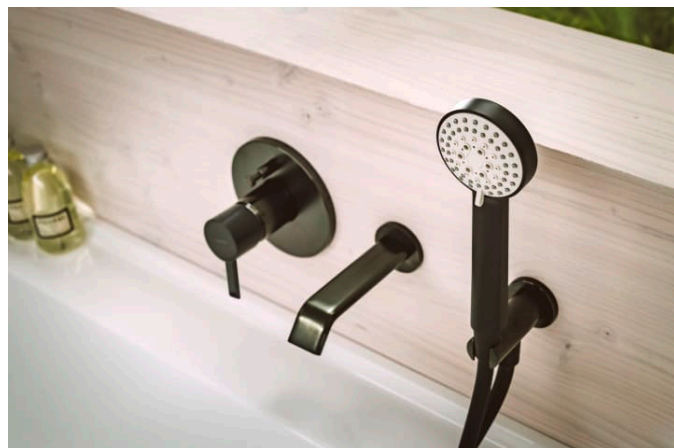

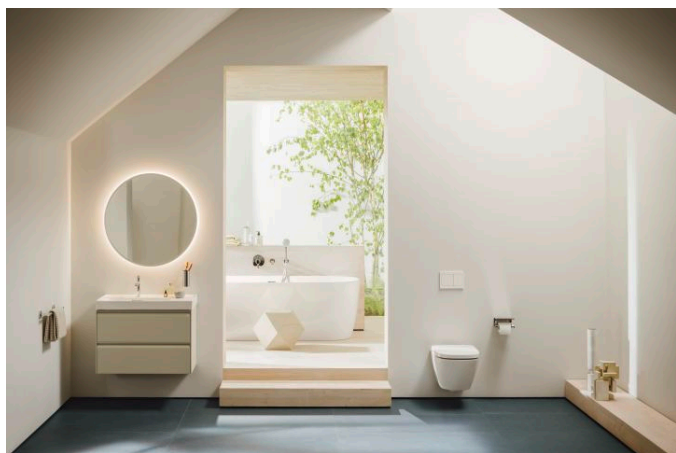

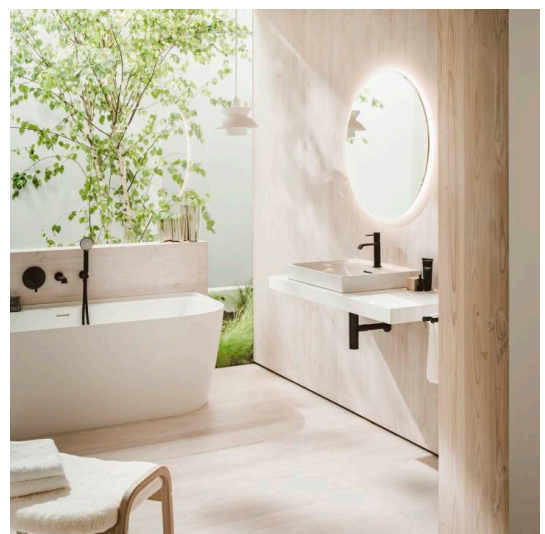
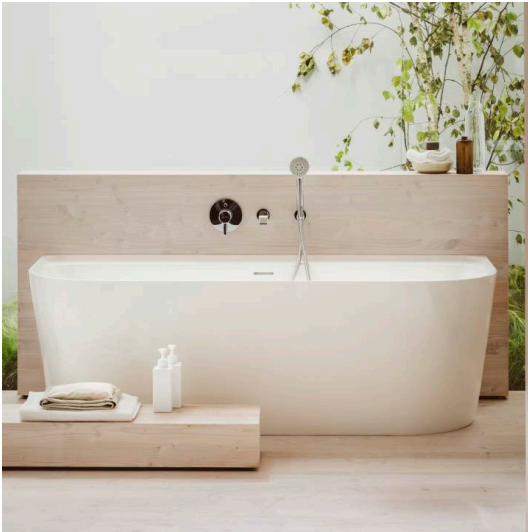

MEDA

Versatile and timeless. The MEDA collection effortlessly complements any setting, from rental apartment to hotel suite, while reflecting the proven virtues of Swiss design; clarity, functionality and attention to detail. A style emblematic of Swiss designer Peter Wirz and his design firm Vetica.

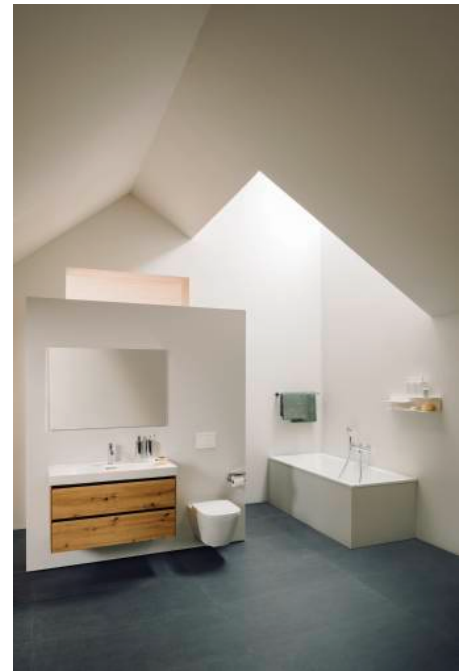

#material_text

MARBOND

Marbond

Marbond is a composite material made of two layers which are extremely well connected with each other: The basis is formed by a high-quality mineral casting material, the surface is coated with a two millimetre thick acrylic layer. Marbond is hygienic, easy to clean, temperature resistant according to EN 263 and anti-slip (class C).